

O-RIO3535

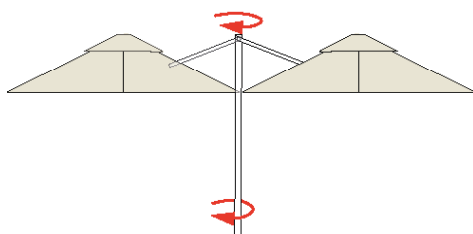

MADE IN ITALY

ROTAZIONE 360°



Ombrellone made in Italy a palo laterale in legno con telo quadrato 3,5x3,5metri.

Palo	Alluminio - 90x90 mm
Braccio	Alluminio - 70x70 mm
Stecche	Intercambiabili alluminio - 20x35 mm
Trattamento alluminio	Verniciato a polveri
Telo*	- 100% acrilico 300 gr - acrilico resinato 390 gr
Balza	Disponibile con o senza balza
Apertura-Chiusura	Carrucola e arganello con manovella
Basamenti	- Base in ferro zincato verniciato a polveri** **con alloggio per marmette 50x50 cm non incluse
Illuminazione opzionale	- Potenza totale: 75 W - Lunghezza strip: 935 mm cover 950 mm - Potenza strip: 19,2 W/mt - Luce 4000 kelvin - Dimeraggio con telecomando

* Gli ombrelloni Danieli si distinguono per la qualità della lavorazione artigianale e dei materiali scelti. Utilizziamo solo tessuti composti da fibra acrilica per garantire solidità alla luce, permeabilità all'aria. Trattato con resine fluorocarboniche che garantiscono: la protezione antimacchia, l'idrorepellenza, la traspirabilità.

La costruzione del tessuto 100% acrilico prevede una trama da 14 fili/cm ca. per un peso di 300 g/mq.

Per il tessuto acrilico resinato, caratterizzato da spalmatura con resine acriliche, è prevista una trama da 17fili/cm e il peso è di 390 gr/mq.

COLORE TELO ACRILICO RESINATO



ecrù

COLORI TELO 100% ACRILICO



ecrù



corda



giallo



festa di moro



tortora



bordeaux



verde foresta



nero



antracite

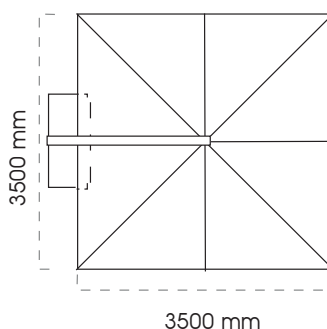
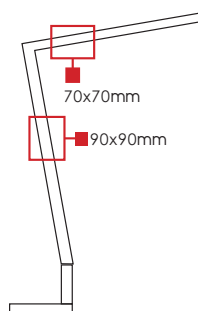
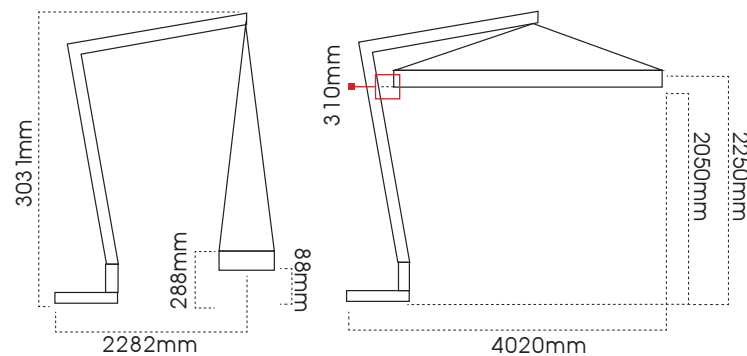

Base in ferro

